

NOTE: DIMENSIONS LOCATED IN BOXES ARE COMMON
SETBACK DIMENSIONS FOR EACH FITTING

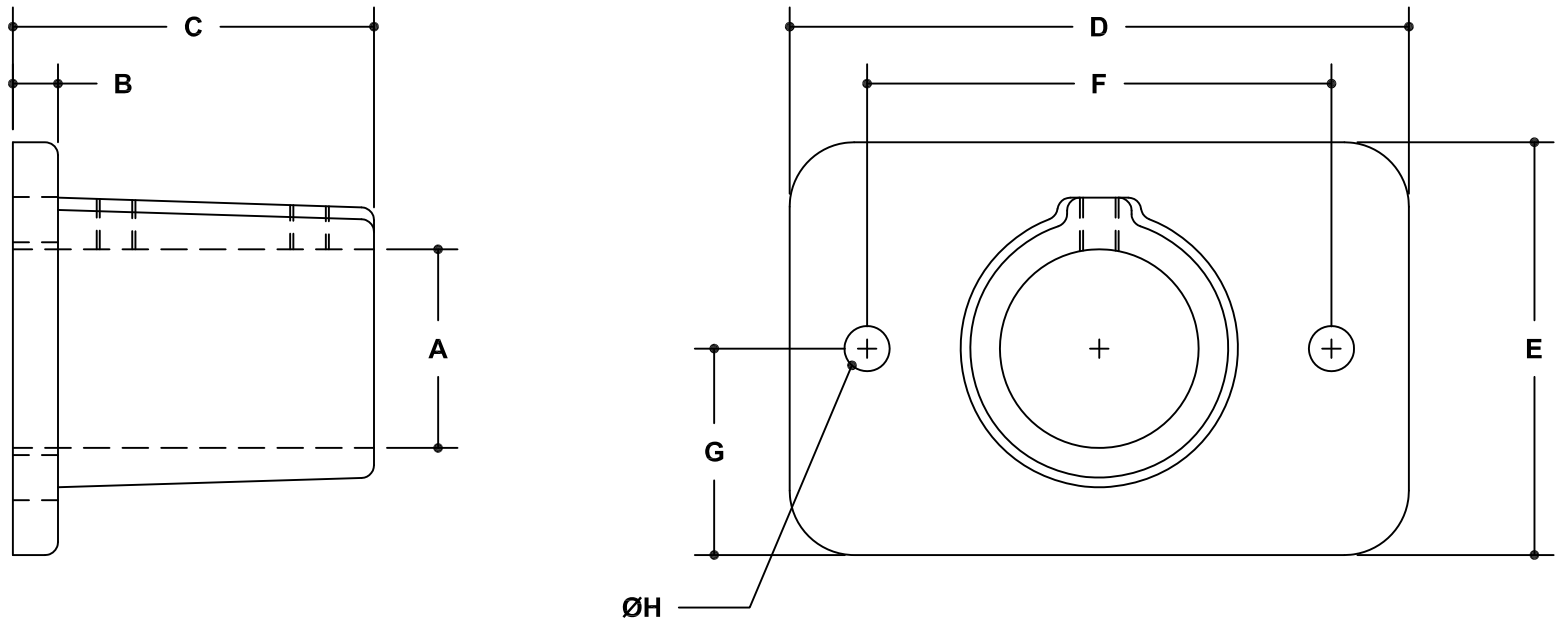

#48 Heavy-Duty Base Flange (2-Hole)

SCALE: HALF

ENGLISH UNITS (Inches)									
PIPE SIZE	A	B	C	D	E	F	G	H	J
2"	2.40	0.56	3.50	8.00	5.00	5.50	2.50	0.81	
1½"	1.93	0.44	3.50	6.00	4.00	4.50	2.00	0.56	

METRIC UNITS (mm)									
PIPE SIZE	A	B	C	D	E	F	G	H	J
2"	61	14	89	203	127	140	64	21	
1½"	49	11	89	152	102	114	51	14	